

JUNPUS INTERNATIONAL CO., LTD.

鈞普國際有限公司

Solar Turn Table

Rotating display movement

太陽能旋轉台機芯

MADE IN TAIWAN

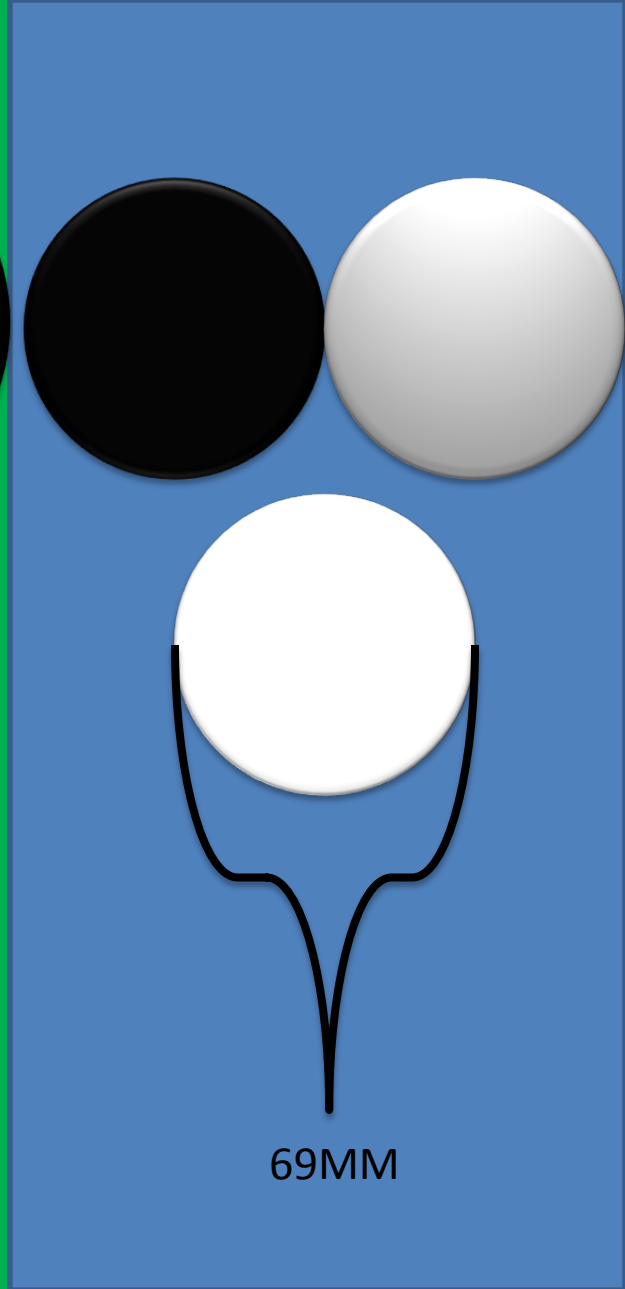
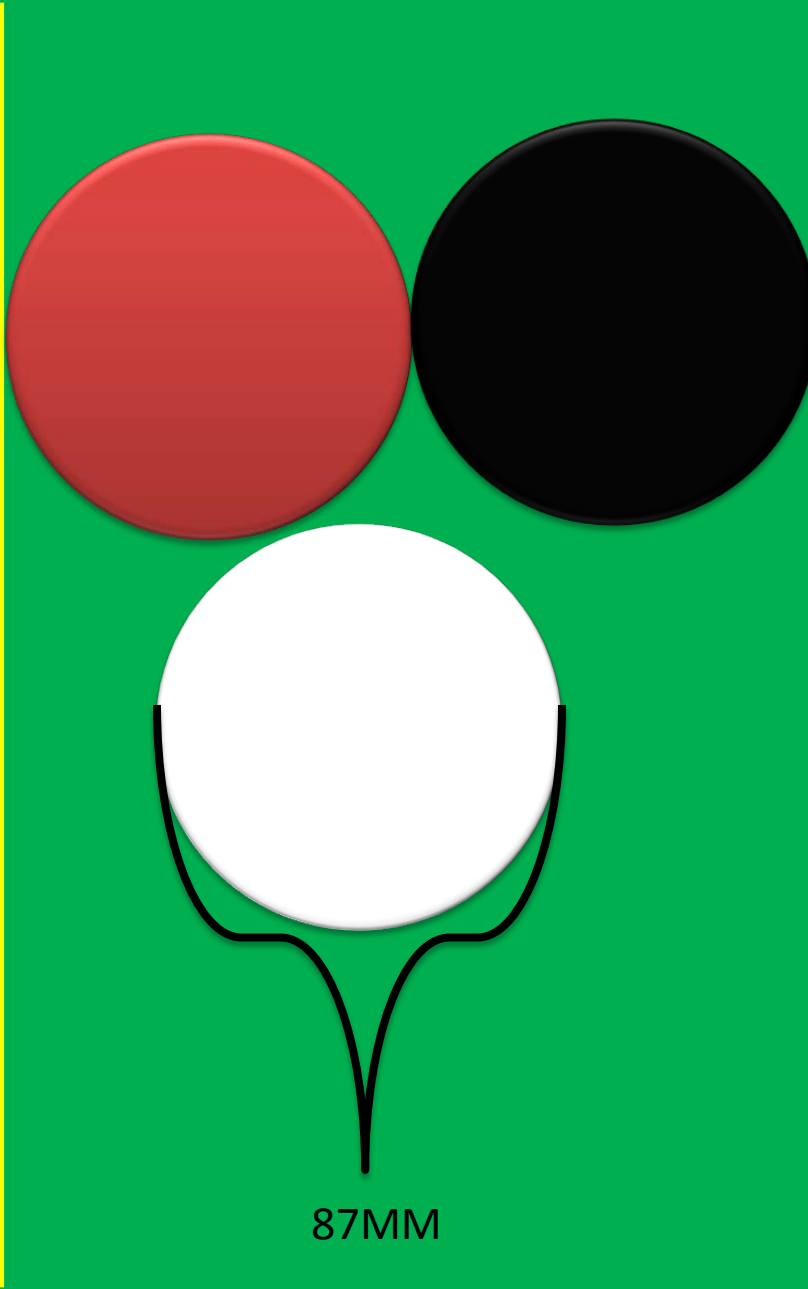
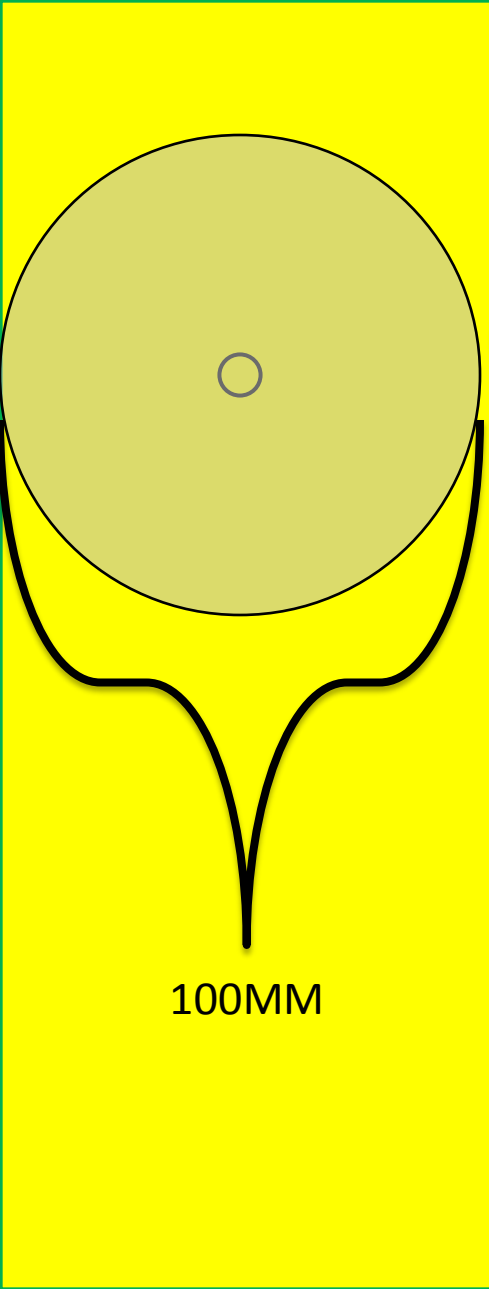

Plate

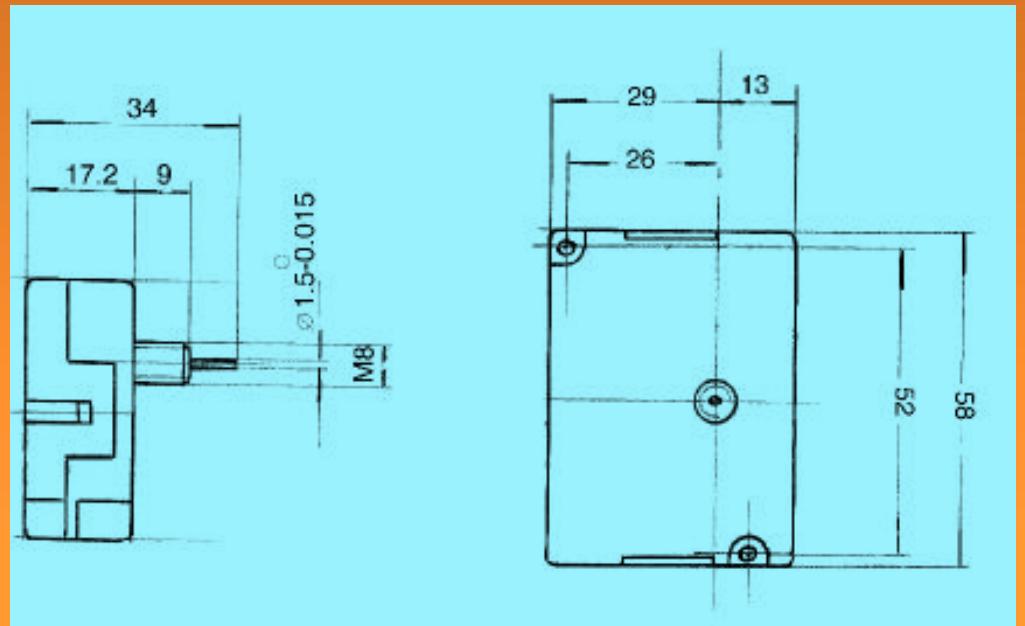
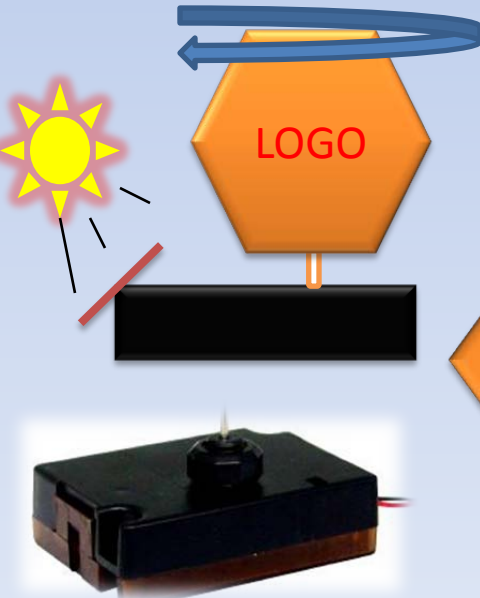
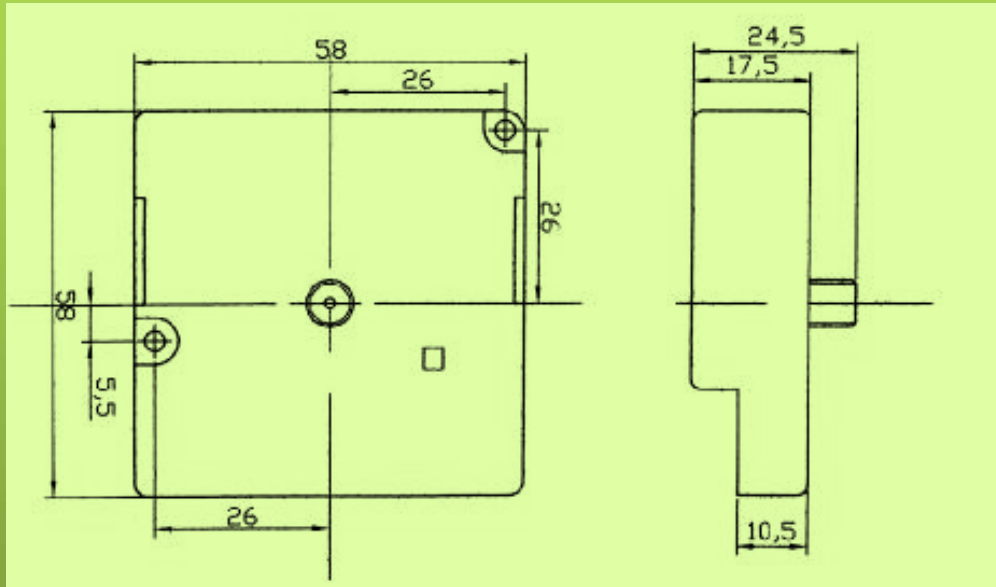

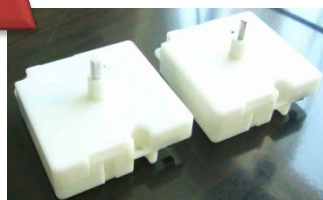

Solar Turn Table

Rotating display movement



ITEN	JP-TD5	JP-TD2	JP-TD1
Unit size	5.8*5.8*1.9CM	2.9*5.8*3.4CM	5.8*5.8*2.45CM
Plate size	100mm(PS) 87mm(PS) 69mm(ABS)	100mm(PS) 87mm(PS) 69mm(ABS)	100mm(PS) 87mm(PS) 69mm(ABS)
Speed	2-3RPM	3-4RPM	3-4RPM
Load capability SOLAR	1000G	500G	500G
Load capability Battery	2000G	NO	500G
Material	ABS	ABS	ABS

Quantity/ctn	500pcs/ctn	600pcs/ctn	500pcs/ctn
G.W./ctn	14.5KG	16KGS	13.5KG
N.W./ctn	13KG	14KG	13KG
Packing Measurement	48*42*39CM	48*42*39CM	48*42*39CM
SOLAR CELL			
ITEN	5832	5816	
Unit size	58*32mm	58*16mm	

JunPus International Co., Ltd.

4F., No.101, Ningsia Rd.

Datong District, Taipei City 10358, Taiwan (R.O.C.)

<http://www.JunPus.com>

TEL:+886 2 2553 9932

FAX:+886 2 2553 3858

MADE IN TAIWAN